



TAKING COMFORT TO A NEW LEVEL

# ATLANTA A220

## CUSHION CONSTRUCTION

### PLATINUM Seat

3 component seat cushion construction made from environmental friendly cold cure molded high density comfort foam with an extra layer of super soft high density foam. All wrapped with high quality fiber padding. Density of molded foam is between 50 to 55 kg.

Platinum Seat Option is produced with the highest environmental standards to protect you and the environment and to minimize undesirable odors.

### POLYESTER FILLED BACK PILLOW

Back cushion filled with polyester ball fiber in three separate chambers with a special designed integrated lumbar pillow for additional comfort and correct lumbar support.

## CUSHION OPTIONS

### DIAMOND Seat Option

Diamond Seat cushion is made with pocket springs with a top/bottom layer of high resilience foam. All wrapped in high quality fiber padding

### FEATHER blend back pillow

A three chamber back pillow with high quality feather and down blended with polyester fiber.



2 SEAT - CORNER - OPEN ENDING CORNER



3 - SEAT WITH OTTOMAN



3 - SEAT

## Standard Features

- Frames are made from solid wood and gross-grain laminated veneer woods.
- All corner joints are reinforced with corner blocks
- Zigzag (Nozag) seat springs with soft front edge.
- Hardboard back support
- Loose seat and back pillows.
- Fabric cushions are reversible.
- Fabric cushions cover can be removed and washed, according to the wash and care instructions for the particular fabric used.
- Reversible corner units (e.g. 3-corner-2 could be changed to 2-corner-3).
- Detachable arms increase flexibility and reduce handling and servicing cost.

## Options

- Different leg design. Number of different wood finishes.
- Leather or fabric choices.
- Diamond Pocket Seat.
- Back cushion with feather and down blend fill

## Size Option

This model is also available with wider seat width (large size).

- 1 seat with 65 cm seat width instead of 57.5 cm
- 2 seat with 130 cm seat width instead of 115 cm
- 3 seat with 195 cm seat width instead of 172.5 cm

Please contact IMG for more information.

1) We can deliver the 3 seat as duo (2 Pillows).  
Dimensions the same as A2202 3 seat.

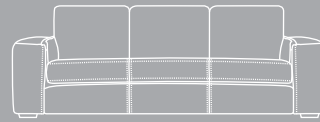

A2202 - 3 SEAT

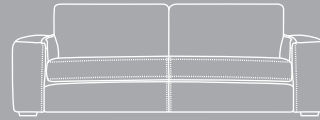

A2202 - 3 SEAT DUO

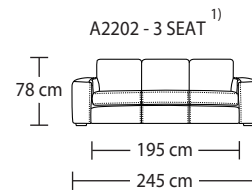

A2202 - 3 SEAT<sup>1)</sup>

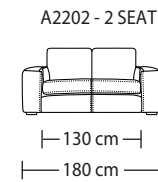

A2202 - 2 SEAT

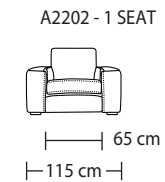

A2202 - 1 SEAT

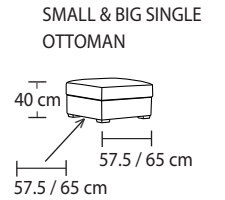

SMALL & BIG SINGLE OTTOMAN

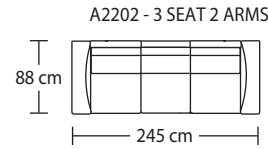

A2202 - 3 SEAT 2 ARMS

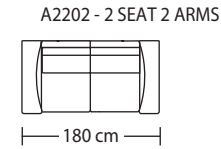

A2202 - 2 SEAT 2 ARMS

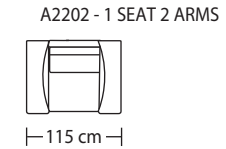

A2202 - 1 SEAT 2 ARMS

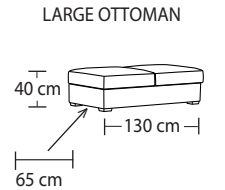

LARGE OTTOMAN

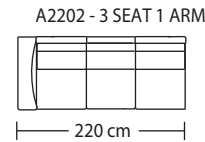

A2202 - 3 SEAT 1 ARM

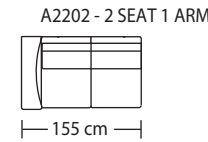

A2202 - 2 SEAT 1 ARM

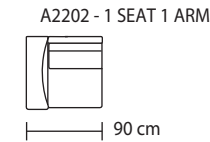

A2202 - 1 SEAT 1 ARM

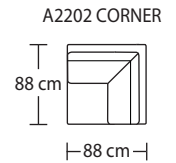

A2202 CORNER

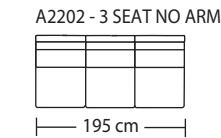

A2202 - 3 SEAT NO ARM

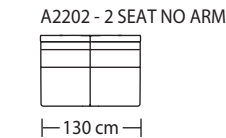

A2202 - 2 SEAT NO ARM

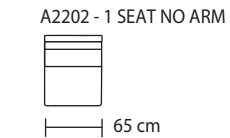

A2202 - 1 SEAT NO ARM

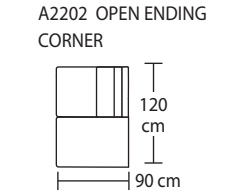

A2202 OPEN ENDING CORNER

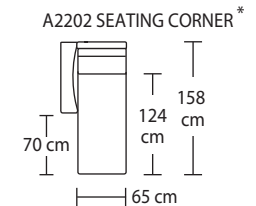

A2202 SEATING CORNER\*

\*Note: This will be delivered as an extra long seat pillow with a supporting front frame.

## Suggested Configurations

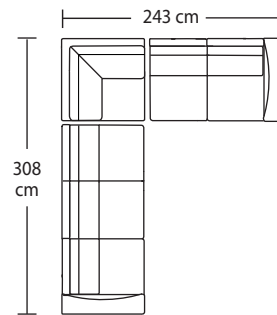

A2202 - 3 SEAT 1 ARM  
A2202 CORNER  
A2202 - 2 SEAT 1 ARM

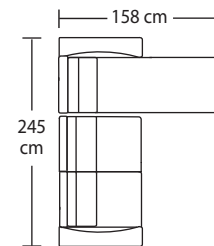

A2202 - 2 SEAT 1 ARM  
A2202 SEATING CORNER

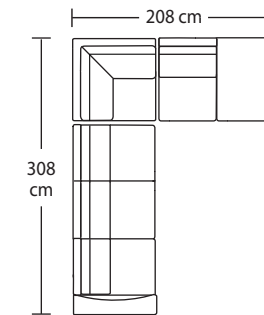

A2202 - 3 SEAT 1 ARM  
A2202 CORNER  
A2202 OPEN ENDING CORNER

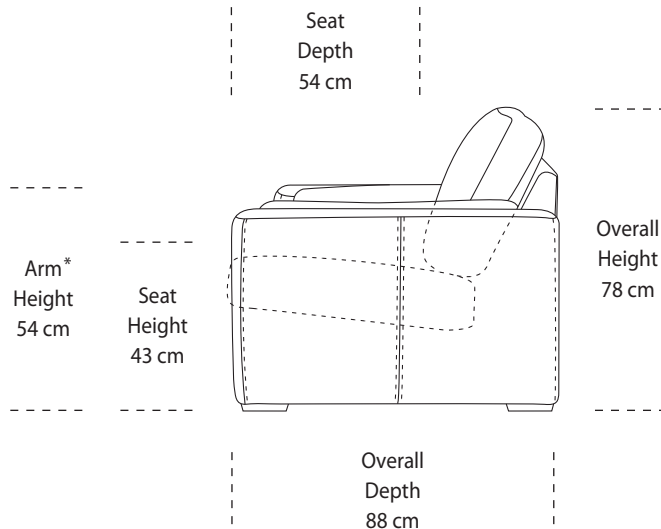

\*Note: arm height for this frame is measured at the highest point of the arm.



TAKING COMFORT TO A NEW LEVEL